

Rubin 2000
Import-Export

Calitatea noastră este calitate



CUTIUTE PENTRU BIJUTERII
PANOURI DE PREZENTARE BIJUTERII
BALANTE
POANSOANE
APARATE PENTRU POANSONAT

www.rubin2000.ro

Rubin 2000
Import-Export

Calitatea noastră este calitatea

Sediu: Str. Finlanda Nr. 2, Sector 1, Bucuresti, Romania

Birouri: Bd-ul Rahova Nr. 266-268 (in incinta Elecromagnetica), Sector 5, Bucuresti, Romania

Tel./Fax: +40 (21) 423 26 02; +40 (21) 423 22 45;

+40 (21) 423 30 05; +40 (31) 102 36 98.

Mobil: +40 (723) 387 320; +40 (722) 379 784; +40 (722) 572 822.

E-mail: sales@rubin2000.ro, rubin@rubin2000.ro

www.rubin2000.ro

PROFILUL COMPANIEI

RUBIN 2000 IMPORT-EXPORT este o companie tanara si dinamica, fiind importator si distribuitor de cutiute pentru bijuterii si ceasuri, panouri de prezentare pentru magazinele de bijuterii, casete si ruloari pentru pastrarea si transportul bijuteriilor.

Noi va propunem idei originale de ambalare si prezentare pentru bijuteriile dumneavoastra si cum ambalajul de efect conteaza, nici un cadou nu este mai bine primit decat unul bine ambalat.

Cutiile oferite de noi sunt unice si au cel mai bun raport pret-calitate. Cu peste 300 de modele de cutiute si peste 200 de modele de panouri de prezentare comercializate, **RUBIN 2000 IMPORT-EXPORT** este unul din liderii de pe piata ambalajelor de bijuterii si panourilor de prezentare pentru bijuterii din Romania.

RUBIN 2000 IMPORT-EXPORT este importator oficial al produselor STUDEX (cercei pentru urechi sensibile). Compania americana STUDEX este liderul de piata in producerea sistemelor de gaurire si cerceilor medicinali.

RUBIN 2000 IMPORT-EXPORT este importator si distribuitor de bijuterii si verighete din aur cu titlu 585 si 750 fabricate in Italia, cu pietre pretioase, semipretioase, naturale si sintetice.

De asemenea **RUBIN 2000 IMPORT-EXPORT** este distribuitor de poansoane de titlu si de garantie proprie, aparate pentru marcat bijuterii, balante omologate pentru bijuterii.

Toate produsele livrate de **RUBIN 2000 IMPORT-EXPORT** poarta semnul sloganului nostru "*Calitatea noastra este calitatea*".

Va asteptam sa ne vizitati!

COMPANY PROFILE

RUBIN 2000 IMPORT-EXPORT is a young and dynamic company, importer and distributors of jewelry cases, jewelry panels and jewelry carrying panels for jewelry and shops.

We propose original ideas for your jewelry. As you know, packing is important and no gift is better received than one nice packed.

The cases we offer are unique (exclusive) and have the best price related to quality. Upwards of three hundred range of jewelry cases and two hundred arrangements panels commercialized, **RUBIN 2000 IMPORT-EXPORT** is one of the Romanian jewelry cases and jewelry panels market leader.

RUBIN 2000 IMPORT-EXPORT is also an authorized importer of the STUDEX products. STUDEX Company is the market leader of ear piercing systems and hypoallergenic earrings.

RUBIN 2000 IMPORT-EXPORT is also importer and distributor of gold jewelry and gold wedding ring with gold 585 and 750, with precious stones, semiprecious, natural and sintetic stones.

RUBIN 2000 IMPORT-EXPORT is also a distributor of: piercers (piercing mandrels), homologate laboratory balances, instruments for manufacturing and marketing of precious metals.

All products of **RUBIN 2000 IMPORT-EXPORT** are under our mark "*Our quality is the quality*".

Come to visit us!

CUPRINS

PROFILUL FIRMEI

AMBALAJE PENTRU BIJUTERII

1. CUTII DIN LEMN

1.1. Colectia WI	5
1.2. Colectia WU-200	5
1.3. Colectia WU-400	5

2. CUTII CATIFEA

2.1. Colectia RE	6
2.2. Colectia 3000	7
2.3. Colectia 3000 CU FEREASTRA	8
2.4. Colectia FD	8
2.5. Colectia FW	9
2.6. Colectia CB	10
2.7. Colectia FIGURINE	11
2.8. Colectia PENTRU CRACIUN	11

3. CUTII PIELE

3.1. Colectia LG-AL	12
3.2. Colectia LG-ECO	12
3.3. Colectia LG-ECO	12
3.4. Colectia E	13
3.5. Colectia LE-PEL	14

4. CUTII DIN CARTON

4.1. Colectia PHB	15
4.2. Colectia PJ	16
4.3. Colectia PL	17
4.4. Colectia RY	18
4.5. Colectia PHW	18
4.6. Colectia PHL [4]	19

5. CUTII IMITATIE PIELE

5.1. Colectia MULTICOLOR	20
5.2. Colectia PE	21
5.3. SCP	21
5.4. Colectia BD	21
5.5. Colectia XTT	21

6. SACULETI

6.1. Colectia JPA	22
6.2. Colectia JPD	22
6.3. Colectia JPE	22
6.4. Colectia LK	22

7. PUNGI PENTRU CADOURI

7.1. Colectia F	23
7.2. Colectia RS	23
7.3. Colectia BG	24
7.4. Colectia RY	24
7.5. Colectia LK	24
7.6. Colectia P	25

PANOURI DE PREZENTARE PENTRU BIJUTERII

1. PANOURI IMITATIE PIELE	26-29
2. PANOURI DIN PLASTIC-FROST EFECT	30-31
3. CASETE PENTRU BIJUTERII	32
4. RULOURI TEXTILE PENTRU BIJUTERII	32

BALANTE ELECTRONICE KERN	33
---	-----------

POANSOANE SI APARATE DE POANSONAT	34
--	-----------

IMPORTATOR SI DISTRIBUTOR DE BIJUTERII



Rubin 2000
Import-Export
Calitatea noastră este calitate



WI-04
83 x 78 x 39 mm
lant/cercei/pendant



WI-06
65 x 57 x 48 mm
inel



WI-05
86 x 78 x 53 mm
verighete

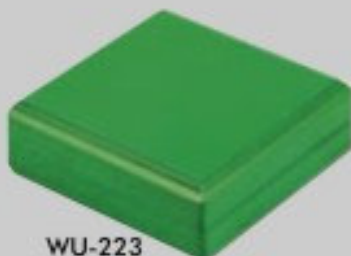

WU-223
140 x 140 x 48 mm
colier

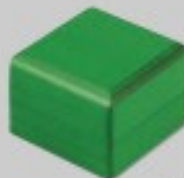

WU-201
70 x 70 x 43 mm
lant/cercei



WU-207
60 x 60 x 50 mm
inel

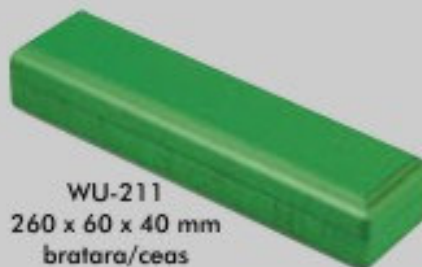

WU-211
260 x 60 x 40 mm
bratara/ceas

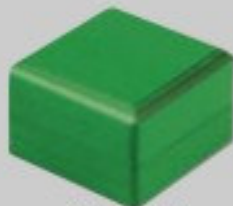

WU-205
95 x 95 x 70 mm
ceas/bratara fixa

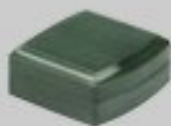

WU-402
60 x 80 x 43 mm
lant/cercei

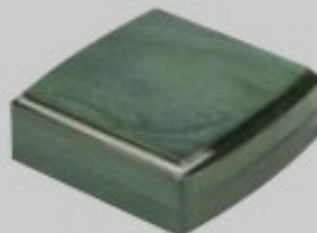

WU-423
220 x 300 x 50 mm
colier

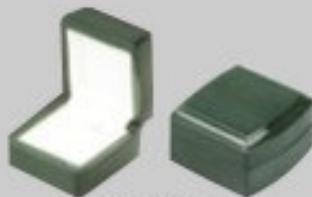

WU-401
70 x 70 x 43 mm
inel

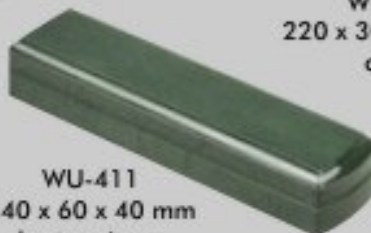

WU-411
240 x 60 x 40 mm
bratara/ceas



RE



RE-6004
60 x 78 x 34 mm
pendant/lantisor



RE-6001
215 x 48 x 26 mm
bratara



RE-6005
45 x 49 x 40 mm
inel



RE-6007
52 x 58 x 31 mm
cercei/lant



RE-6002
77 x 98 x 59 mm
ceas



RE-6012
190 x 190 x 40 mm
colier/set





3001XS
220 x 31 x 24 mm
bratara/ceas

3000



3001
218 x 49 x 27 mm
bratara/ceas

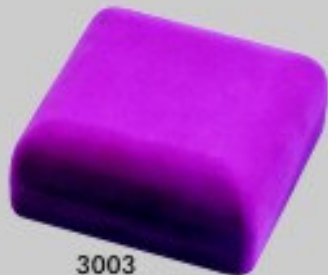

3003
93 x 93 x 41 mm
bratara fixa/ceas



3003M
93 x 93 x 41 mm
medalie



3004
61 x 78 x 31 mm
cercei/lantisor cu pendent



3007
45 x 48 x 37 mm
inel



3011
38 x 44 x 36 mm
inel



3010
183 x 67 x 27 mm
stilou



3055
163 x 163 x 28 mm
colier



3019
45 x 51 x 24 mm
cercei/lantisor cu pendent



3000



3034
54 x 50 x 34 mm
inel



3036
47 x 48 x 34 mm
inel



3035
50 x 45 x 34 mm
inel



3037
45 x 54 x 34 mm
inel



3057
140 x 130 x 40 mm
colier



3040
51 x 52 x 35 mm
inel



3018
57 x 59 x 42 mm
cercei/lant



3018S
38 x 41 x 31 mm
inel



3018
57 x 59 x 42 mm
lant/cercei

FD



FD-11
250 x 53 x 30 mm
inel



FD-6
72 x 48 x 35 mm
verighete



FD-2
50 x 50 x 38 mm
inel



FD-1
64 x 82 x 30 mm
pandant/lantisor

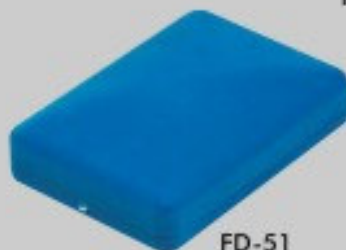

FD-51
107 x 155 x 37 mm
colier





FW-1
54 x 44 x 32 mm
cercei



FW-2
54 x 44 x 37 mm
inel



FW-3
57 x 57 x 29 mm
lantisor/pendant



FW-5
84 x 84 x 32 mm
lantisor/pendant



FW-6
57 x 83 x 29 mm
lantisor/pendant



FW-7
105 x 152 x 29 mm
colier

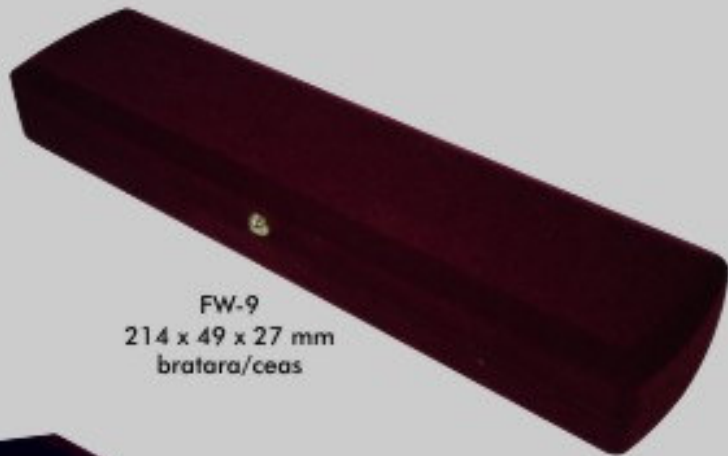

FW-9
214 x 49 x 27 mm
bratara/ceas

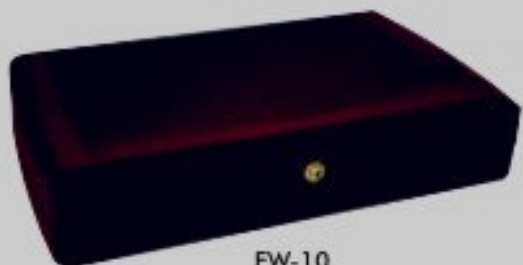

FW-10
149 x 98 x 29 mm
colier



AMBALAJE PENTRU BIJUTERII - Cutii Catifea



CB



CB-7011
224 x 49 x 36 mm
bratara



CB-7012
153 x 132 x 43 mm
colier

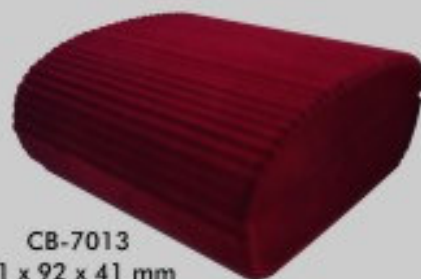

CB-7013
91 x 92 x 41 mm
pandant/lantisor



CB-7014
46 x 46 x 39 mm
pandant/lant



CB-7020
46 x 46 x 39 mm
inel



CB-7017
92 x 93 x 58 mm
ceas/bratara

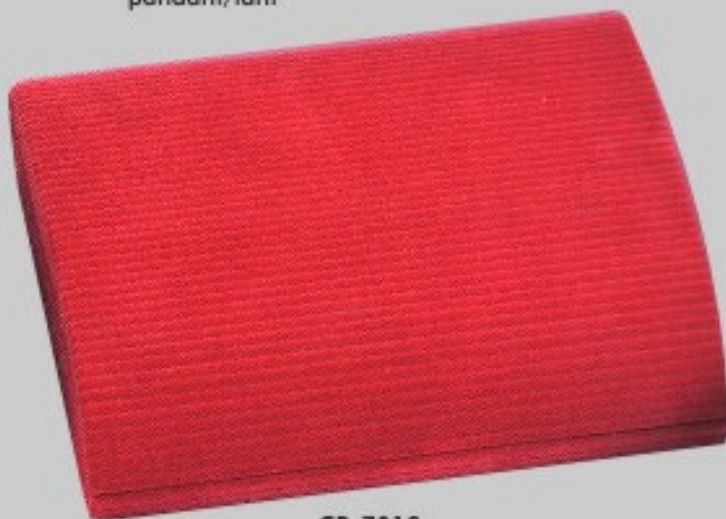

CB-7019
190 x 160 x 45 mm
colier



CB-7021
78 x 54 x 41 mm
inel/verighete



FANTEZII



8027
53 x 67 x 45 mm
inel



5004
60 x 43 x 37 mm
inel



5027
42 x 40 x 52 mm
inel



FC-6
64 x 51 x 42 mm
inel



5003
35 x 33 x 44 mm
inel



3038
46 x 43 x 55 mm
inel



2006
64 x 51 x 42 mm
inel



5018S
39 x 42 x 63 mm
inel

FU



FU-111
50 x 45 x 71 mm
inel



FU-54
62 x 62 x 59 mm
inel



FU-53X
41 x 54 x 39 mm
inel



LG-AL-01
218 x 55 x 36 mm
bratara

LG-AL



LG-AL-06
50 x 58 x 40 mm
inel

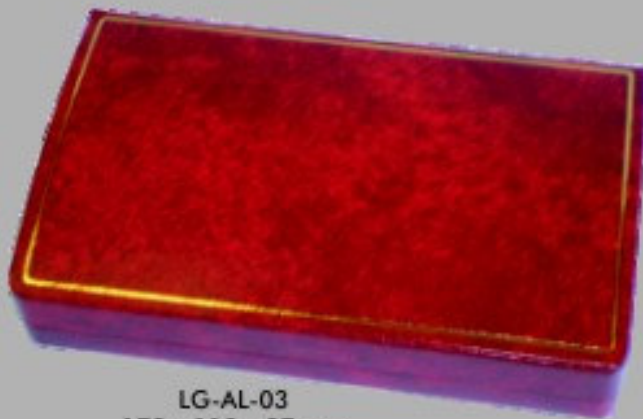

LG-AL-03
179 x 110 x 37 mm
set



LG-AL-07
85 x 92 x 38 mm
lantisor/pandant



LG-AL-05
70 x 54 x 39 mm
inel/verighete

LG-ECO



LG-ECO-05
74 x 48 x 40 mm
verighete

LA-ECO



LA-ECO-05
74 x 48 x 40 mm
verighete



LA-ECO-06
47 x 52 x 40 mm
inel



LA-ECO-01
222 x 51 x 28 mm
bratara/ceas



E

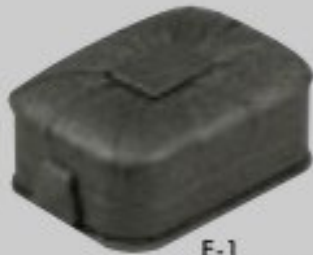

E-1
69 x 95 x 40 mm
pandant/lantisor



E-5
104 x 105 x 68 mm
verighete/inel



E-11
244 x 60 x 36 mm
bratara



E-26
199 x 248 x 58 mm
set



E-51L
124 x 172 x 46 mm
colier

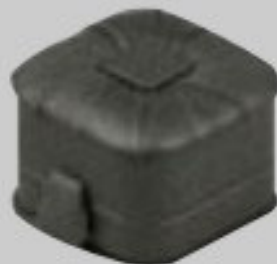

E-7
69 x 69 x 52 mm
inel

LE-
PEL

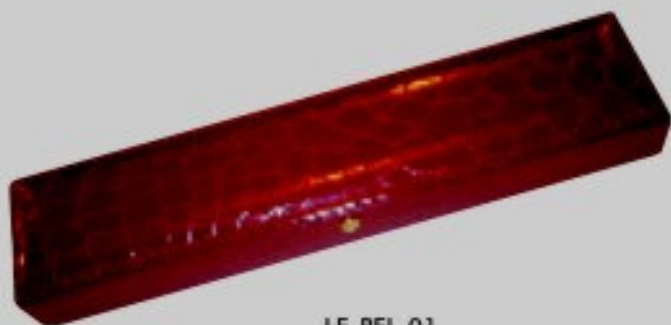

LE-PEL-01
222 x 51 x 28 mm
bratara



LE-PEL-03
93 x 93 x 70 mm
bratara/ceas

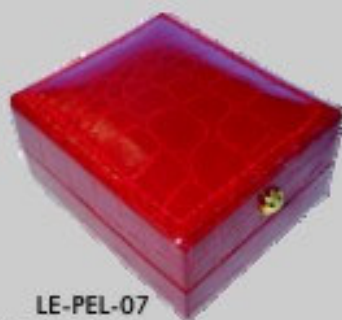

LE-PEL-07
52 x 63 x 31 mm
lantisor/pendant



LE-PEL-05
74 x 48 x 42 mm
inel/verighete

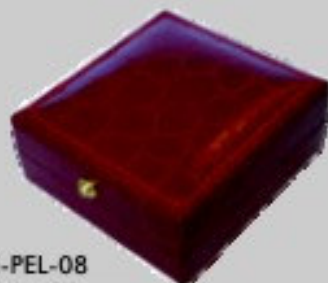

LE-PEL-08
64 x 69 x 29 mm
cercei



LE-PEL-06
47 x 53 x 41 mm
inel



LE-PEL-14
120 x 186 x 31 mm
set



LE-PEL-17
91 x 83 x 53 mm
ceas/bratara

PHB



PHB-01
205 x 46 x 25 mm
bratara



PHB-02
140 x 165 x 35 mm
set



PHB-05
49 x 55 x 35 mm
inel



PHB-08
50 x 55 x 23 mm
cercei/lant



PHB-12
61 x 61 x 22 mm
cercei/lant



PHB-09
84 x 84 x 60 mm
ceas/bretara

PJ



PJ-01
216 x 46 x 30 mm
bratara



PJ-02
152 x 129 x 39 mm
set



PJ-04
74 x 69 x 33 mm
cercei/lantisor



PJ-05
54 x 49 x 38 mm
inel



PJ-03
95 x 95 x 43 mm
universala



PJ-07
103 x 101 x 62 mm
ceas/bratara

PL



PL-01
219 x 54 x 30 mm
bratara



PL-02
190 x 202 x 38 mm
colier/set



PL-04
68 x 78 x 35 mm
pandant/lantisor



PL-05
57 x 46 x 44 mm
inel



PL-06
87 x 82 x 37 mm
colier/set



RY



RY-1
49 X 54 X 22
cercei/pendant



RY-2
57 x 51 x 34
inel



RY-9
203 x 102 x 22
bratara/ceas



RY-10
127 x 165 x 32
colier



RY-5
84 x 84 x 32
bratara/ceas

PHW



PHW-05
49 x 55 x 35 mm
inel



PHW-03
74 x 99 x 31 mm
lantisor



PHW-06
85 x 85 x 35 mm
universala

PHL(4)



PHL(4)-01
205 x 46 x 25 mm
bratara



PHL(4)-02
140 x 165 x 35 mm
colier



PHL(4)-04
55 x 80 x 25 mm
ceas/lantisor



PHL(4)-05
49 x 55 x 35 mm
inel



PHL(4)-06
85 x 85 x 35 mm
universal



PHL(4)-08
50 x 55 x 23 mm
cercei/lant



PHL(4)-10
239 x 54 x 26 mm
bratara

1000



1000-HB
50 x 50 x 35 mm
inel

1000-HBS
50 x 50 x 35 mm
inel



3000-HB
51 x 44 x 35 mm
inel



3000-HBS
51 x 44 x 35 mm
inel

3000

5000



5000-HB
47 x 47 x 35 mm
inel



5000-HBS
47 x 47 x 35 mm
inel



7000-HB
44 x 44 x 35 mm
inel

7000

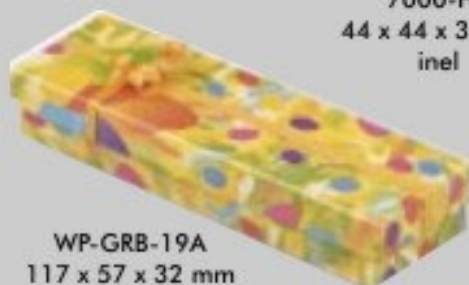

WP-GRB-19A
117 x 57 x 32 mm
UNIVERSALA



7000-HBS
44 x 44 x 35 mm
inel

PE



PE-4
66 x 86 x 37 mm
cercei/lantisor

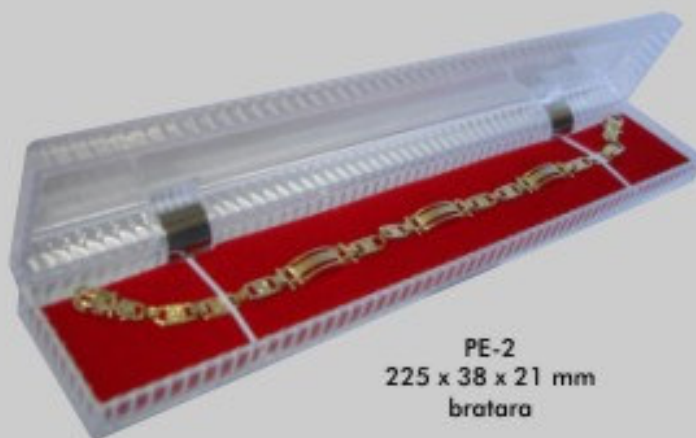

PE-2
225 x 38 x 21 mm
bratara



PE-14
40 x 40 x 40 mm
inel



PE-18
60 x 37 x 40 mm
inel

BD



BD-6
44 x 54 x 29 mm
inel



BD-6L
60 x 89 x 19 mm
lantisor/pendant



BD-6S
44 x 54 x 21 mm
cercei

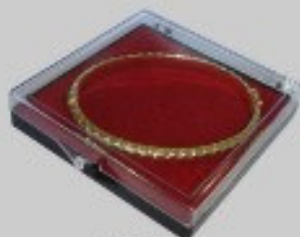

LK-9T
76 x 76 x 17 mm
universala

SCP



SCP-05
34 x 39 x 19 mm
universala

XTT



XTT-20R
50 x 52 x 32 mm
inel



XTT-20
50 x 52 x 32 mm
inel



JPA



JPA-01	57 x 72 mm
JPA-02	60 x 85 mm
JPA-03	70 x 95 mm
JPA-04	80 x 120 mm
JPA-05	90 x 130 mm
JPA-06	100 x 140 mm
JPA-07	110 x 150 mm
JPA-08	120 x 160 mm
JPA-09	130 x 170 mm
JPA-10	140 x 180 mm

JPD-01	55 x 82 mm
JPD-02	70 x 100 mm
JPD-03	78 x 112 mm
JPD-04	86 x 124 mm
JPD-05	96 x 136 mm
JPD-06	105 x 148 mm
JPD-07	113 x 160 mm
JPD-08	123 x 172 mm
JPD-09	131 x 184 mm
JPD-10	140 x 196 mm



JPD

JPE

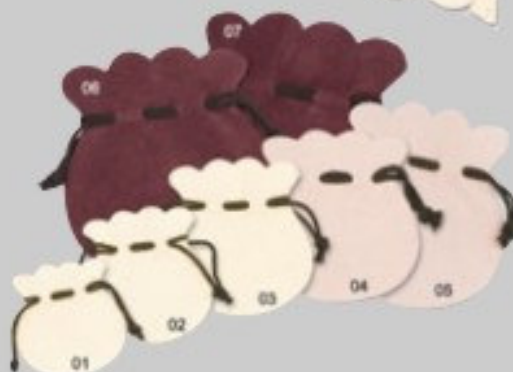

JPE-01	62 x 68 mm
JPE-02	72 x 78 mm
JPE-03	82 x 90 mm
JPE-04	95 x 103 mm
JPE-05	109 x 119 mm
JPE-06	125 x 137 mm
JPE-07	144 x 157 mm



LK-25
63 x 76 mm
catifea cu snur



LK-41M
57 x 57 mm
textil metalizat



LK-44M
83 x 102 mm
textil metalizat

LK



LK-41
57 x 57 mm
catifea cu snur



F



PUNGUTE DE PLASTIC

F-01	50 X 70 mm
F-02	60 x 85 mm
F-03	70 x 100 mm
F-04	85 x 120 mm
F-05	100 x 140 mm
F-06	120 x 170 mm
F-07	125 x 125 mm
F-08	140 x 200 mm
F-09	170 x 240 mm
F-10	200 x 280 mm
F-11	240 x 350 mm

RS



RS-1
70 x 100



RS-3
120 x 150



RS-4
120 x 300



BG



BG-1
63 X 80 X 44 mm



BG-2
80 X 116 X 66 mm



BG-4
151 X 215 X 76 mm



BG-3
151 X 215 X 76 mm

RY



RY-L
157 X 235 X 50 mm



RY-S
100 X 118 X 50 mm



RY-M
63 X 240 X 37 mm

LK



LK-49
79 X 66 X 117 mm



LK-51
140 X 63 X 127 mm



LK-46
63 X 44 X 79 mm

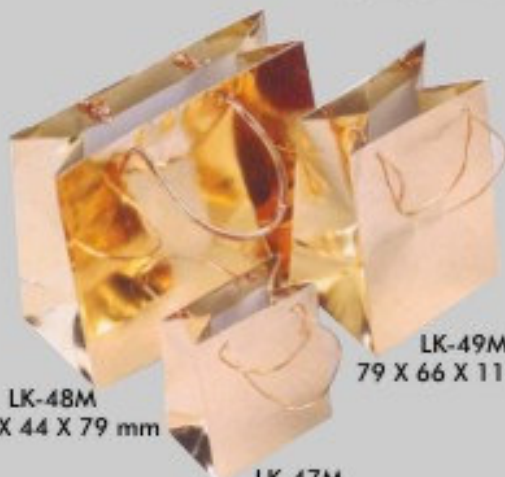

LK-48M
139 X 44 X 79 mm

LK-49M
79 X 66 X 117 mm

LK-47M
63 X 44 X 79 mm



LK-52M
76 X 32 X 121 mm

LK-50M
152 X 76 X 216 mm

LK-50
152 X 76 X 216 mm



P



P4
465 x 345 x 200



P1
120 x 390 x 90



P2
170 x 270 x 60



P3
245 x 400 x 90

AMBALAJE PENTRU BIJUTERII - Pungi



B1
40 x 198 x 52 mm
panou bratara



BA1
129 x 38 x 56 mm
panou bratara



BA2
71 x 61 x 73 mm
suport bratara fixa



BA5
58 x 58 x 85 mm
suport bratara

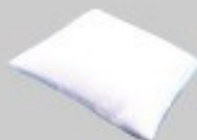

BA3
78 x 78 x 35 mm
suport bratara fixa

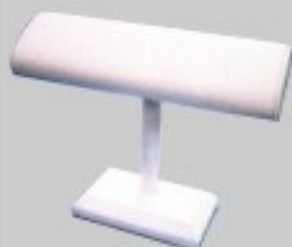

SB6SG
188 x 62 x 156 mm
panou bratari

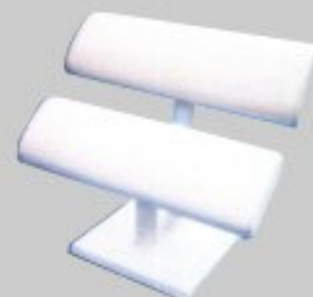

SB6DB
192 x 115 x 181 mm
panou bratari



SB10DB
234 x 166 x 193 mm
panou bratara

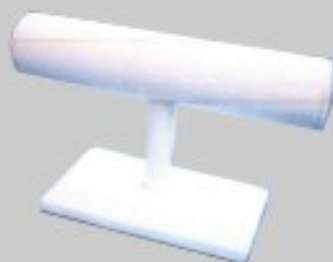

SB7
192 x 70 x 126 mm
panou bratara



SBA4-12P
313 x 223 x 43 mm
panou bratara fixa



SB4-18P
357 x 190 x 11 mm
panou bratara



SBA3-5P
219 x 140 x 42 mm
suport bratara

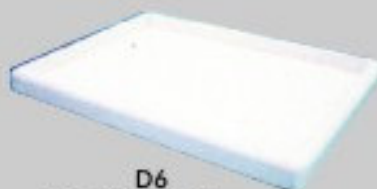

D6
265 x 190 x 21 mm
caseta de prezentare



SB2
216 x 154 x 102 mm
panou bratara



SN3-15P
377 x 302 mm
panou lanturi



N9
191 x 218 mm
bust



SN1-4P
362 x 216 x 32 mm
panou set coliere



N1
148 x 140 x 170 mm
bust



N4
124 x 92 x 149 mm
bust



SN4-25P
225 x 313 x 26 mm
panou lanturi



N12
212 x 317 mm
bust



N16
185 x 152 x 275 mm
bust



N22
78 x 94 x 42 mm
bust



N23
80 x 85 x 78 mm
bust



N11
210 x 317 mm
bust



P6
50 x 37 x 67 mm
suport lant/pendant



SP7-54P
360 x 100 x 187 mm
suport cercei



P3M
85 x 35 x 100 mm
suport lant/pendant



N29
148 x 140 x 170 mm
bust



SP8-26P
360 x 100 x 187 mm
suport cercei



SE12-25P
313 x 225 x 26 mm
suport cercei



SE4-20P
147 x 230 x 57 mm
cercei



E7
40 x 18 x 42 mm
suport cercei



E6
41 x 17 x 30 mm
suport cercei



ER3
57 x 43 x 86 mm
suport cercei



SE3-18P
377 x 211 x 27 mm
panou cercei



SE7-16P
229 x 187 x 45 mm
panou cercei



E1
41 x 41 x 98 mm
suport cercei



SP2-24P
377 x 211 x 27 mm
suport cercei



ER2
83 x 64 x 26 mm
suport inel/cercei



ER1
58 x 58 x 94 mm
suport cercei/inel



ER5
54 x 140 x 170 mm
suport cercei/inel



ER4
70 x 63 x 42 mm
panou cercei/inel

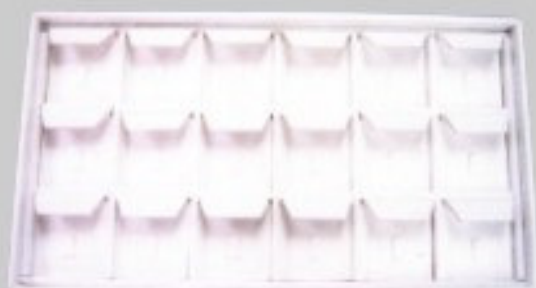

SER2-18P
377 x 211 x 27 mm
panou cercei



SEP2-28P
313 x 224 x 40 mm
suport cercei/pandant



SR10-30P
313 x 225 x 39 mm
panou inele



R1L - set
58 x 55 x H
suport inel



SR20
193 x 32 x 28
suport inele



SR7-35P
313 x 224 x 40 mm
panou inele



SBH1-16P
313 x 225 x 26 mm
panou brosa



R2 - set
42 x 37 x H
suport inel



R7
35 x 33 x 1 mm
suport inel



R6
20 x 23 x 55 mm
suport inel



R3 - set
33 x 33 x H
suport inel



SR3-51P
355 x 189 x 6 mm
panou inele



SR2-11P
125 x 109 x 39 mm
panou inele



SR2-5P
125 x 109 x 39 mm
panou inele



SR5-19P
228 x 199 x 40 mm
panou inele



HN-10/F
175 x 63 x 210 mm
suport lanturi



HN-0204/F
140 x 45 x 190 mm
suport lanturi



HBA-0201/F
300 70 x 85 mm
suport bratari



SR-15S/F
25 x 25 x H mm
suport inel



HE-0201/F
140 x 45 x 190 mm
suport cercei



HE-01/F
194 x 60 x 103 mm
suport cercei



SR-0201/F
200 x 18 x 20 mm
suport inele



SN-84/F(H)
104 x 76 x 137 mm
suport lanturi



SN-84/F(M)
83 x 70 x 113 mm
suport lanturi



HB-0201/F
150 x 223 x 68 mm
suport bratari



SN-84/F(L)
44 x 42 x 57 mm
suport lanturi



SB-0202/F
35 x 220 x 52 mm
suport bratara



HR-10/F
182 x 150 x 12 mm
suport inele



SE-0201/F(H)
34 x 35 x 95 mm
suport cercei



SE-0201/F(M)
34 x 35 x 79 mm
suport cercei



SE-0201/F(L)
34 x 35 x 55 mm
suport cercei



SE-0202/F(H)
34 x 38 x 70 mm
suport cercei



SE-0202/F(M)
34 x 28 x 52 mm
suport cercei



SE-0202/F(L)
34 x 15 x 30 mm
suport cercei



SE-33/F
42 x 28 x 58 mm
suport cercei

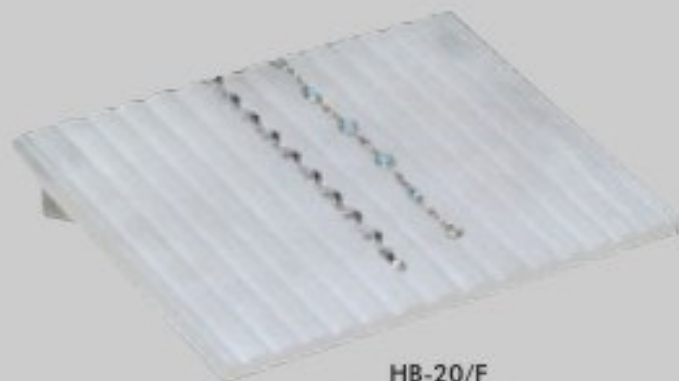

HB-20/F
240 x 168 x 35 mm
suport bratari



SE-0204/F
32 x 20 x 58 mm
suport cercei



B3-0117N
215 x 166 x 88 mm
caseta portabila cu 10 piese

B



B5-4001R
255 x 90 x 88 mm
caseta pentru inele



B4-0117N
215 x 166 x 88 mm
caseta portabila cu 10 piese

P



PC-1601
255 x 90 x 88 mm
Rulou lanturi



PB-2001
255 x 90 x 88 mm
Rulou bratari



PB-01
255 x 90 x 88 mm
Rulou bratari



EW

Model KERN	Greutate (max)(g)	Precizie (g)
EW 150-3M	150	0.001
EW 600-2M	600	0.01
EW 1500-2M	1500	0.01
EW 3000-2M	3000	0.01
EW 6000-1M	6000	0.1



PRJ

Model KERN	Greutate (max)(g)	Precizie (g)
PRJ 320-3M	320	0.001
PRJ 620-3M	620	0.001



TCB

Model KERN	Greutate (max)(g)	Precizie (g)
TCB 120-1	120	0.1



GJ

Model KERN	Greutate (max)(g)	Precizie (g)
GJ 410-3M	410	0.001
GJ 610-2M	610	0.01



EG

Model KERN	Greutate (max)(g)	Precizie (g)
EG 220-3NM	220	0.001
EG 420-3NM	420	0.001
EG 620-3NM	620	0.001



TMB

Model KERN	Greutate (max)(g)	Precizie (g)
TMB 120-1	120	0.1
TMB 250-1	250	0.1
TMB 360-1	360	0.1/0.2



CM

Model KERN	Greutate (max)(g)	Precizie (g)
CM 60-2N	60	0.01
CM 150-1N	150	0.1
CM 320-1N	320	0.1
CM 1K1N	1000	1

POANSON DE TITLU

Poanson AUR



585

Poanson AUR

750

Poanson ARGINT

925

-  585 Poanson AUR
-  750 Poanson AUR
-  925 Poanson ARGINT



POANSON DE GARANTIE PROPRIE

Poanson PLATINA

B 374

CT 010

Poanson AUR

B 374

CT 010

Poanson ARGINT

B 374

CT 010



Marimea literelor : 0.35 mm
0.50 mm
0.75 mm
1.00 mm

APARAT DE POANSONAT

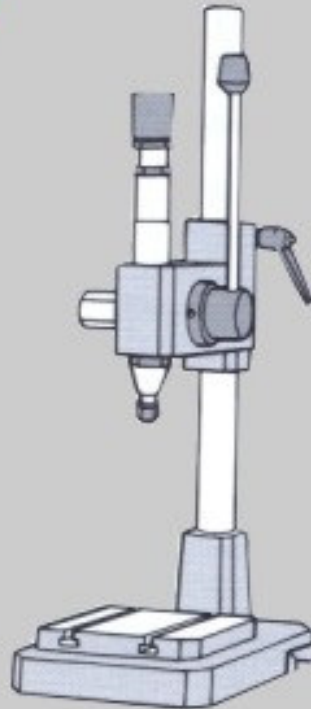



STUDEX®

MADE IN U.S.A.

CERCEI STERILI SI ACCESORII

REPREZENTAT DE

Rubin 2000
Import-Export

Calitatea noastră este calitate

COMANDA

Va rugam sa considerati aceasta o comanda ferma pentru urmatoarele produse / servicii:

Nr. crt.	Denumire produs/ serviciu	Caracteristici/ Specificatii	Cod Produs	Cantitate	Pret unitar (fara TVA)	Valoare (fara TVA)
					TOTAL COMANDA	

ALTE CERINTE:

- va rugam confirmati in scris primirea comenzii si acceptarea termenului de livrare pentru data de
- modalitati de plata OP Cash BO CEC
- termene de plata: in avans / la livrare / in termen de zile de la receptie
- transport asigurat de furnizor: da / nu
- livrarea se efectueaza la sediul beneficiarului / punct de lucru
- produsul trebuie insotit de / Instructiuni de utilizare // declaratii de conformitate // buletin de verificare metrologic // aprobare de model

La prezenta se ataseaza documentatia de executie / modelul / macheta (daca este cazul): / DA / NU

CONFIRMARE COMANDA:

S.C RUBIN 2000 IMPORT EXPORT S.R.L.
 (Semnatura, stampila)

BENEFICIAR
 (Semnatura, stampila)

Termen de livrare: _____